



Photo du modèle avec option sellerie PREMIUM épaisseur 8cm

*Divan d'examen à hauteur fixe
Gamme 326*

32606TB-CONFORT

CARINA
Medical



CE
ISO 9001
ISO 13485

DESCRIPTION TECHNIQUE

- Divan d'examen à hauteur fixe mixte, 3 parties
- Tête et jambièrre réglables par vérins à gaz
- Sellerie tendue plate de bonne densité 30kg/cm², non feu classée M1, épaisseur 5cm
- Equipé d'un porte rouleau pour drap d'examen côté tête
- Piètement acier peint époxy, coloris gris clair (RAL 7035) en standard

DIMENSIONS

- Largeur 60cm
- Hauteur 65cm
- Capacité de charge: 130kg

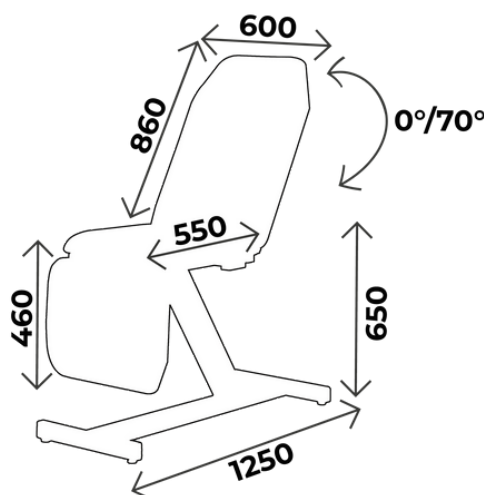

A SAVOIR

- ✓ Délai: 15 jours à réception commande
- ✓ Garantie: 5 ans (1 an pour la sellerie)

Vous aimerez aussi :

Ref. **32607TB**: Idem 32606TB mais largeur 70cm

ACCESSOIRES



ACC 999
Support roulettes escamotables
diam 50mm pour 326 fixe, 3
parties

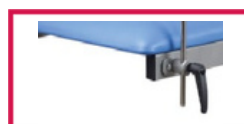

ACC 990
Jeu de 4 roulettes à frein diam 125mm



ACC 76
Paire d'étaux pour fixation
gouttières et étriers diam 14mm



ACC 32012
Tige porte-sérum diam 16mm 2
crochets plastiques, sans étau



ACC 110
Gouttière prise de sang
Avec ferrure, sans étau, l'unité



ACC 110POLY
Gouttière prise de sang polyuréthane
avec ferrure
Sans étau, l'unité

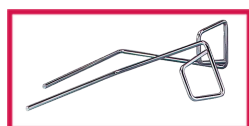

ACC 105
Jeu d'étriers inox standard, diam
14mm, sans étau



ACC 964
Jeu de repose jambes noir, sur
rotule, mousse polyuréthane,
diam 14mm, sans étau



SLFEMIREPOSE
Housse pour repose jambes
(ACC964), l'unité



ACC 514-UNIVERSE
Protection plastique
transparente universelle



ACC 32670
Tête 1/2 lune largeur 70cm,
revêtement non feu M1



ACC TETERGO
Tête ergonomique amovible



SELLERIE PREMIUM
Sellerie épaisseur 8cm au
lieu des 5cm standard, non
feu classée M1



ACC BARRILIT326B
Paire de barrières de lit
escamotables pour 326
mixte



ACC 832
Trou visage avec bouchon



ACC 76B
Etau unitaire diam
14mm



ACC 76C
Etau unitaire pour tige
porte sérum diam 16mm

COLORIS SELLERIE

Sellerie non-feu
classée M1

Pour les coloris de sellerie, vous avez le choix entre la gamme classique et Urban

Revêtement : Sellerie Gamme Classique

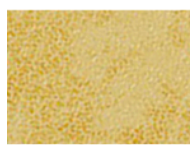

Arno



Garonne



Potomac

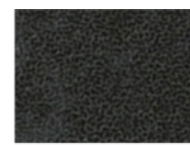

Amour

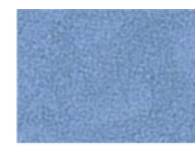

Mississippi



St Laurent

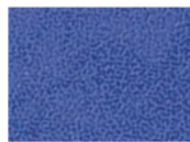

Rhône

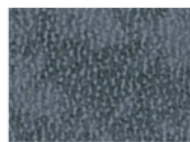

Missouri



Seine



Amazone

Revêtement : Sellerie Gamme Urban



Abysse



Cendre



Origan



Géranium



Réglisse



Prune

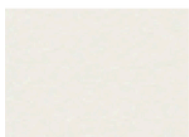

Perle



Ficelle

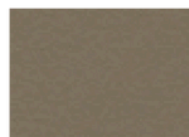

Terre

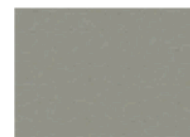

Béton

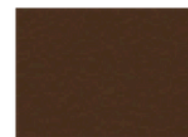

Chataigne

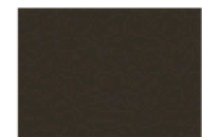

Chocolat

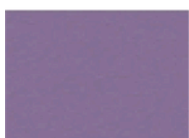

Pensée



Pétrole



Turquoise



Granny



Absinthe

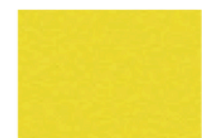

Ananas



Orange













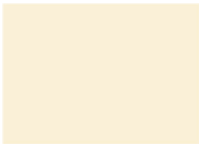
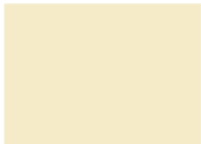
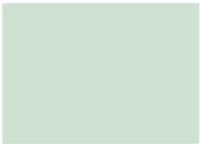

Fuschia

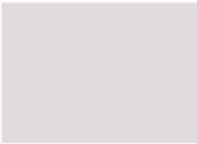

Tomate

COLORIS PIÈTEMENT

*Toute la gamme 326 est proposée en coloris (RAL 7035) en standard
Possibilité de changer le coloris de piètement sans plus value*

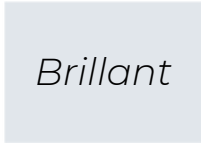
				
RAL 9003	RAL 1013	RAL 1015	RAL 6019	RAL 6033
				
RAL 6000	RAL 5017	RAL 5002	RAL 5000	RAL 7035
				
RAL 7016	RAL 9005	RAL 1018	RAL 3020	RAL 3003
				
		ARGENT		



GUIDE D'ENTRETIEN

ENTRETIEN QUOTIDIEN

Sellerie: Nettoyage à l'eau savonneuse uniquement (solvants proscrits) peut être désinfecté avec des produits tels que Phagosept Spray, Salvanios ph10 à 0,75% et Anios Surfaces Hautes, sans matière abrasive

Piètement: Nettoyage à l'eau savonneuse uniquement (solvants proscrits) sans matière abrasive

GARANTIE

Châssis: 5 ans

Sellerie: 1 an



CONTACT

CARINA
Médical

Parc d'entreprises Visionis
278 rue de l'industrie
01090 GUÉREINS- FRANCE

SERVICE COMMERCIAL

Tel : +33(0)4 74 66 69 49
Fax : +33(0)4 74 66 69 50
commercial@carinamedical.com